

Article number: 03002016

Description: Fluro Rod End GA 16
Zinc Plated

Measures

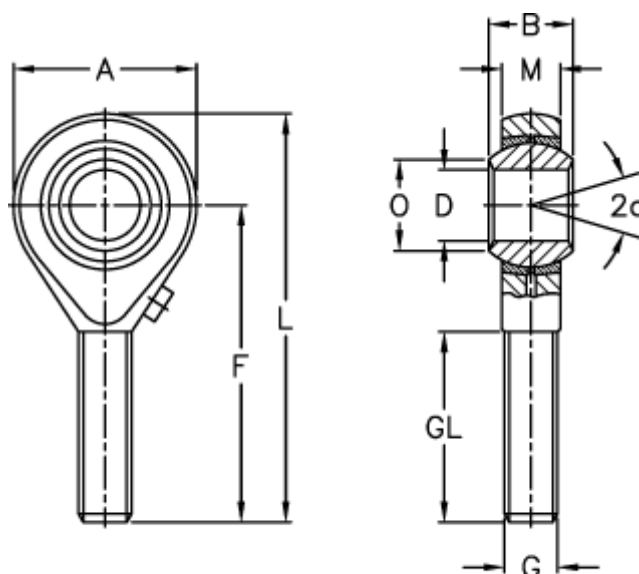

Str. 5 uden smørenippel

A	= 42	L	= 87
a (degrees)	= 15	M	= 15
B	= 21	O	= 19.3
D	= 16	Permissible rpm	= 350
Dynamic load C (kN)	= 16	Static load C0 (kN)	= 36.5
F	= 66	Weight (g)	= 189
g	= M16		
GL	= 40		